



Dr.HD 1000Combo

Dr.HD 1000S+



Multifunctional Signal Meter

USER'S MANUAL

Greetings from the creators of the Multifunctional Signal Meter

Thank you for purchasing our modern and convenient Multifunctional Satellite (Satellite+Terrestrial) Meter! You have made the right choice. Although the Multifunctional Signal Meter is very compact and inexpensive, we did our best to make it universal and easy to use. At the same time, this Multifunctional Meter has many functions that will make the manufacturers of the other “big” models feel jealous. We have employed special team with real field experience, and also we have conducted extensive field tests for each prototype during Research&Development time.

We hope you will enjoy using our Multifunctional Meter for years to come!

I. Package Contents

1. Multifunctional Meter Dr.HD 1000 Combo or S+
2. Power supply unit
3. Remote control unit
4. Car charger cable
5. TV out cable: 3xRCA CVBS Output + R/L mono audio Output
6. CCTV camera cable (CVBS In + Audio In + DC Output)
7. Service cable RS232
8. Universal bag case with straps
9. User guide
10. Batteries*

(*Optional: when customer requests air-shipping, sometimes not possible to ship with batteries.)

II. Before You Start

This Multifunctional Satellite Meter is a cutting-edge product. For the most efficient and long-lasting unit operation it is important to read this user's manual before using.

Before operating this Multifunctional Satellite/Combo Meter (Later: “Meter”) – you should keep an eye on safety precautions contained on this page and throughout the Manual. Following these guidelines, you will enjoy safe operation of the Meter; if you ignore them, you may face some unwanted consequences, and warranty to the Meter may be void.

Safety Warnings:

- Never open the Meter housing or PSU (power supply unit) under any circumstances at home. Some parts are under high voltage when connected to AC. For repair, you should call for qualified engineers.

- If you ever need to replace the external Power Supply Unit (later: PSU), use only the same Dr.HD original PSU. Using with any other PSU may damage the Meter and void the warranty. Same about the car charging cable.
- Do not endanger your Meter by placing it in a humidity environment; never operate it in high humidity conditions. Let it dry after outdoor use.
- If you leave your Meter at your home (or in a car) for a long time, please disconnect the PSU from the AC outlet or DC connector.
- If the Meter has been exposed to low temperatures (storage, transportation) – do not unpack and do not use the Meter for at least 12 hours: open the gift box after contents reach normal indoor temperature.
- Do not spill any liquid on the Meter or PSU. If this happens, immediately switch off the AC and call for Support Service qualified personnel.
- In high temperature conditions, do not cover the metal housing of the Meter with any cover. This housing is the only mean to dissipate the heat. Do not use the Meter in extremely hot temperatures for long time.
- Do not hit your Meter and don't put heavy items on top of it.
- Keep your Meter out of reach of children.
- Update to latest software version, available at www.dr-hd.com
- Switch battery off, when Meter is not in use for a long time

The main functions:

- Rapid spectrum for finding signal.
- Our proprietary SAT ID (Satellite IDentification) function for fast-reading the Broadcaster Name, Satellite, Orbital Position, etc.
- Powerful functions for both initial tuning and fine tuning of antennae.
- Multiple display modes: signal bar + AGC, SNR, BER, MER value, etc.
- Signal Constellation function.
- Stream analyzer for easy frequency + network + satellite name identification. Also displayed: satellite orbital position, network name, modulation (modulation type, transponder frequency, symbol rate, FEC). Additionally: list of transponder services, including data type, provider name, service name, encryption status.
- Possible to watch FTA services without scanning the transponder.
- Possibility of motor dish tuning.
- Internal database, including satellites, transponders, providers.
- Possible to edit database from front panel, from remote control and from PC.
- Blind scan database creation, using real signals.
- Flexible antenna systems control. Selection of: LNB polarization, LNB power, LNB oscillator control (by 22kHz signal), LNB LO frequency selection, DiSEqC 1.0/1.1/1.2/USALS/UNICABLE control, including cascading switches connection. Possible upgrade to DiSEqC 2.0, depending on software.
- Possible to charge from AC, DC 12V, and from any satellite receiver. (Recommended to use 13V/Vertical Polarisation whenever possible). Also can work, powered by PSU.
- Short-circuit protection of LNB input.
- Universal bag for fastening to the belt, to hand and to neck. With sun-blinds and dedicated LED-bar to work under direct sun.
- Remote control for use as STB and faster number entry.
- CCTV Installation function.
- Can be used as RV/Caravan satellite (+terrestrial, only in Combo model) receiver

III. Interfaces

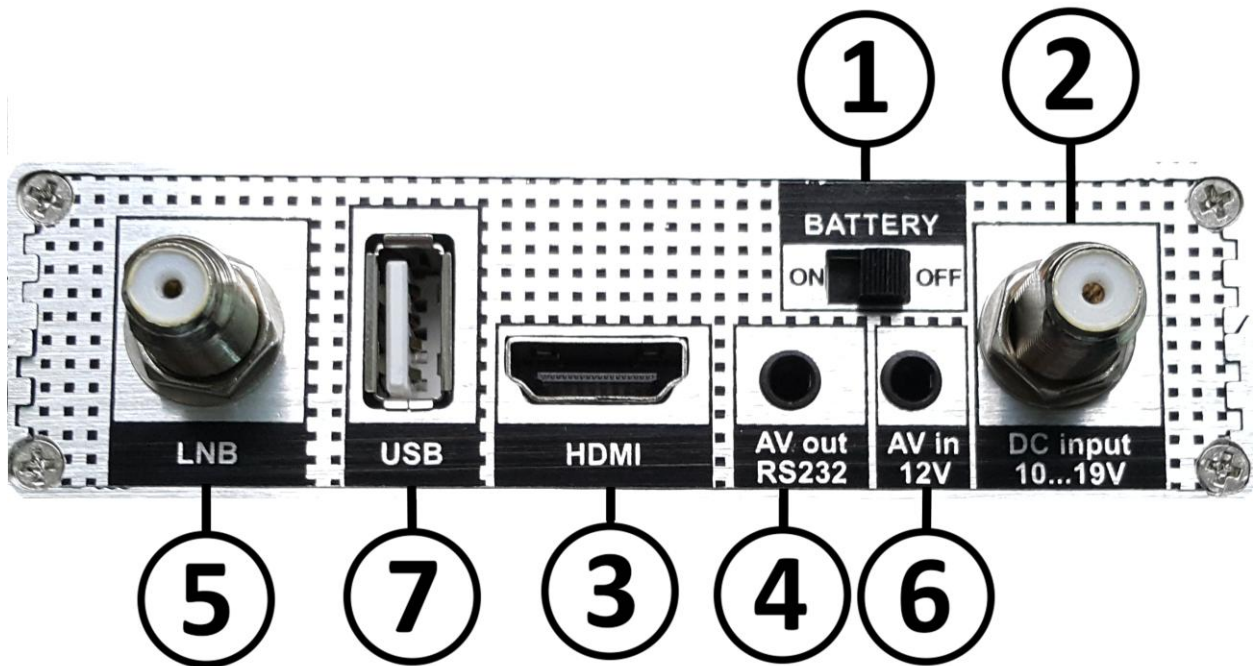

1. **BATTERY ON/OFF** switch (sometimes called as Main Switch) is for battery disconnection. When in OFF position, it prevents battery self-discharge, when Meter is not used.

2. **DC Input 10...19V** is the external supply for the battery charge and power supply to Meter in the active mode. (Recommended to use 13V / Vertical Polarisation whenever possible when charging/powering from satellite receiver).

3. **HDMI** out for TV connection.

4. **AV out** for CVBS + Mono Audio connection to old style TV. Also, works as **RS232 port** when special cable is connected. Both cables are included.

5. "**LNB**" connector. Antenna cable connects here. LNB in satellite mode, also terrestrial TV antenna and active antenna are connected here (only in Combo model). This connection has a shortcut protection.

6. **AV in / 12V**. Input for CCTV cameras and CVBS (video+audio). Special cable is required (included). Also provides power output for CCTV cameras.

7. **USB** socket for software and settings updates / backups (USB stick is required). Also, the Dr.HD USB Wi-Fi dongle can be used here.

IV. Battery

The Multifunctional Satellite Meter is equipped with a high quality Li-Ion battery, which allows you to work off-grid for a long enough period. For better efficiency and longer usage, we recommend that you Switch off the battery with main switch to prevent self-discharge when the Meter is not used. Working time heavily depends on LNB loading, polarization mode and temperature. Remember that shorter working is achieved in cold environment, and also when horizontal polarization is used on Universal LNB. So, switch to Vertical Polarization (13V) whenever convenient. Also, Motorised Dish installation drains battery quickly when motor is powered from Meter. Average working time is around 3 hours for typical 100mA universal LNB at room temperatures (25 C, 75F).

IMPORTANT: The Meter is guaranteed to work only with **original Dr.HD battery**. Using of unapproved by Dr.HD batteries can damage the meter and voids the warranty. Please ask authorized dealer/distributor of Dr.HD if you ever need to change battery.

V. Battery Charge and Power Supply

To charge the Meter, connect external power supply, switch the Main Switch to ON position and make sure that the Meter is in the main menu (battery symbol on display). If all is done correctly, the display will show a charging battery symbol and the "Battery" LED will become RED. When battery charge is finished, the LED will change color to GREEN. If battery switch is in OFF position and PSU is connected, you will see LED flashing red/green continuously. **After opening a new Meter – fully charge it for few hours, until LED is green.**

When the Meter is powered by internal battery, the display will show the battery charge status in percents. The same symbol can be found as an icon in other menu pages. It helps the operator to understand how much time remains.

NOTE: the working time depends on consumed current. Therefore, the remaining percentage value displayed may change significantly in a short time, when power consumption is substantially changing.

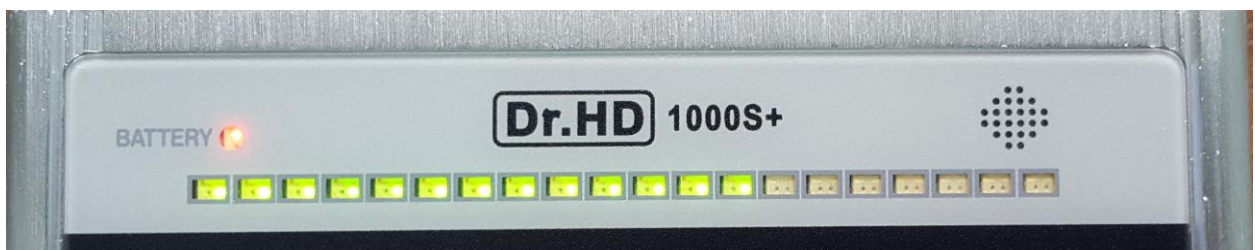

Charge is going, around 60% is done



Charge was well done, 100%

WARNING!

We have tried to make our Meter as user-friendly as possible. We made it possible to charge from any satellite STB, if needed. However, there are important limitations, which you should know about.

1. Please, charge or work from stabilized Power Supply Unit providing from 12 to 15 volts, with current no less than 1A and no more than 2A. We recommend to use **ONLY** the Dr.HD PSU (12V, 2A) that we provide with the Meter. Also, you can **charge** from the DC car charging cable that we provide.
2. If main battery is flat (low), you can work with the the Dr.HD PSU (12V, 2A) that we provide with the Meter. But, in case of short-circuit in the LNB cable, the Meter won't be able to show the red warning message about over-current, instead it will reboot to protect itself. This kind of reboot is normal, it is for protection. Please check your LNB cable immediately and find a reason for over-current.
3. If necessary, you can charge from the LNB IN port of any Satellite receiver. To avoid over-heating, remember to switch the receiver to any transponder with Vertical polarisation, so the receiver provides 13 Volts to the cable. This is important.
4. NOTE: If necessary, it is possible to work from any satellite receiver's power (13V, vertical), but we do not recommend to work on STB power, because STB supplies only 500mA power and it won't be enough power to safely run the Twin/Quad/Unicable LNB, etc.
5. **The safest operation is always from the internal battery. Please, use it whenever possible.**
6. Using other Power Supply Units, except provided by Dr.HD (12V, 2A) is prohibited, especially if the PSU units are providing more than 2A power. These power supply units could be not stabilized, not filtered, not protected and simply dangerous to use. The warranty does not cover use with such PSUs.

VI. Main menu and control

Main menu is user friendly and very simple for any dish pointing. You will spend short time for any installation, and learning how to use Meter easy, fast and fun. That is what we call **EFFective: Easy, Fast and Fun**.

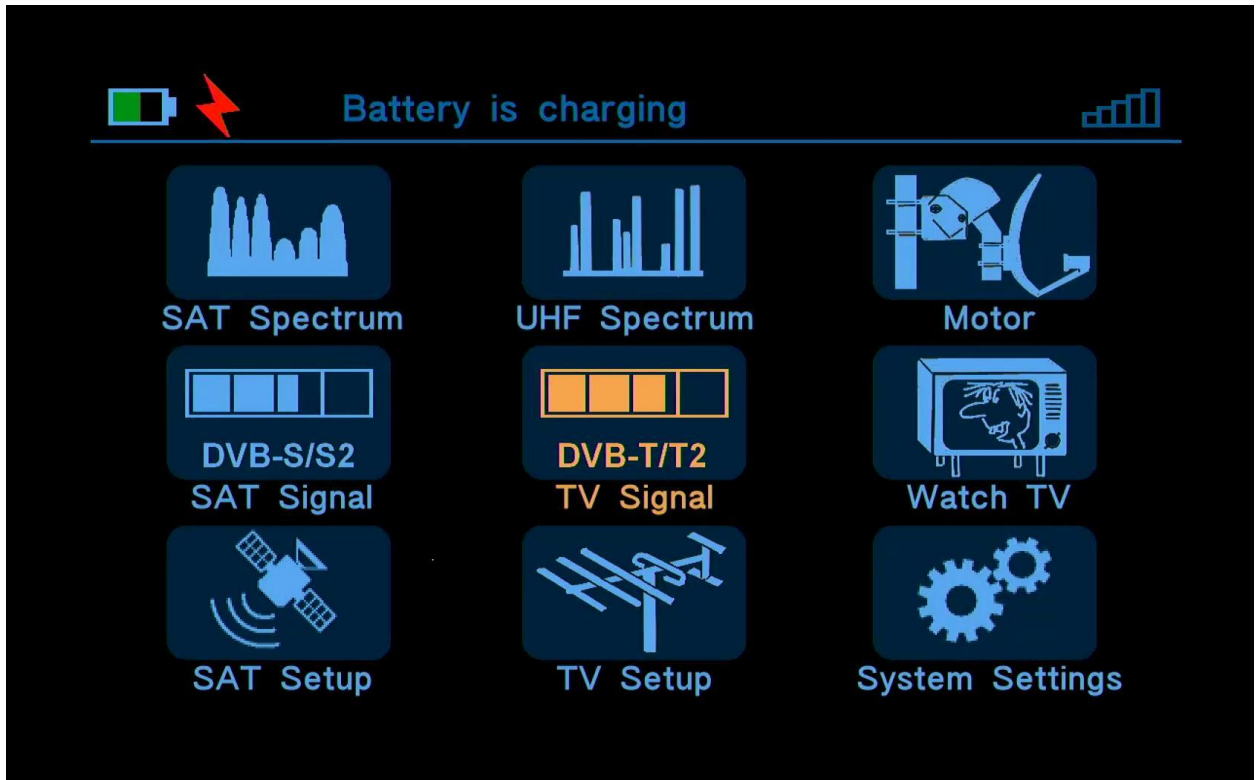

Its main menu of 1000Combo model

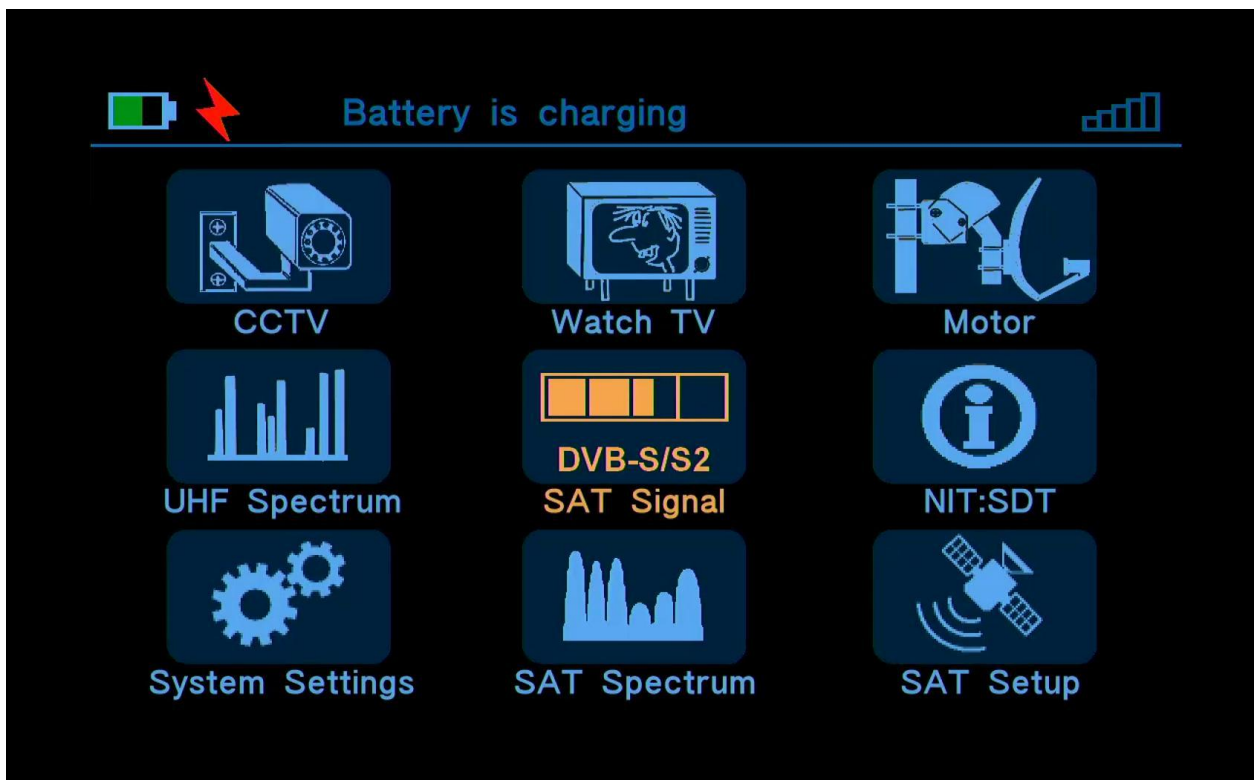

Its main menu of 1000S+ model

Main menu contains 9 icons with main functions. Use arrow keys ▲, ►, ▼, ◀. and **OK** for menu items navigation and selection. Press **BACK** key to return one level menu up and press **MENU** key to go back to Main (Start) menu directly from any other menu.

Color keys (**red, green, yellow, blue**) are used as hot keys for direct access to some important functions. All these color keys are context-dependent, so look at the screen's bottom area for the hints.

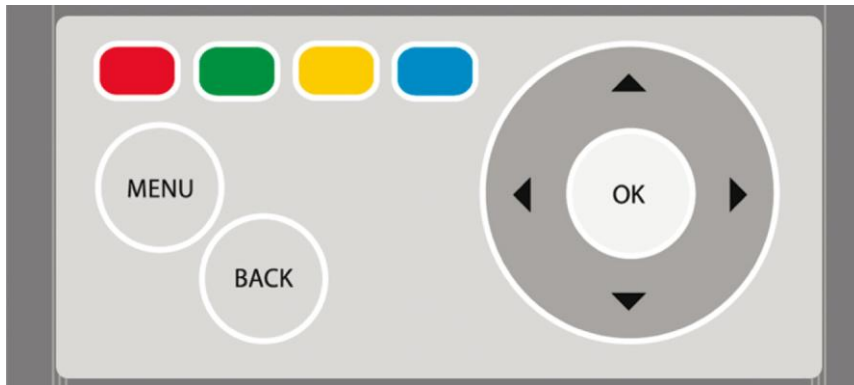

VII. Main functions

SATellite Spectrum

Each dish installation should start with this function. It is possible to control LNB in this mode and **EFF**ectively monitor all the relevant frequencies/transponders, in real time. So it is easy to align antenna, noticing when strong signal is received.

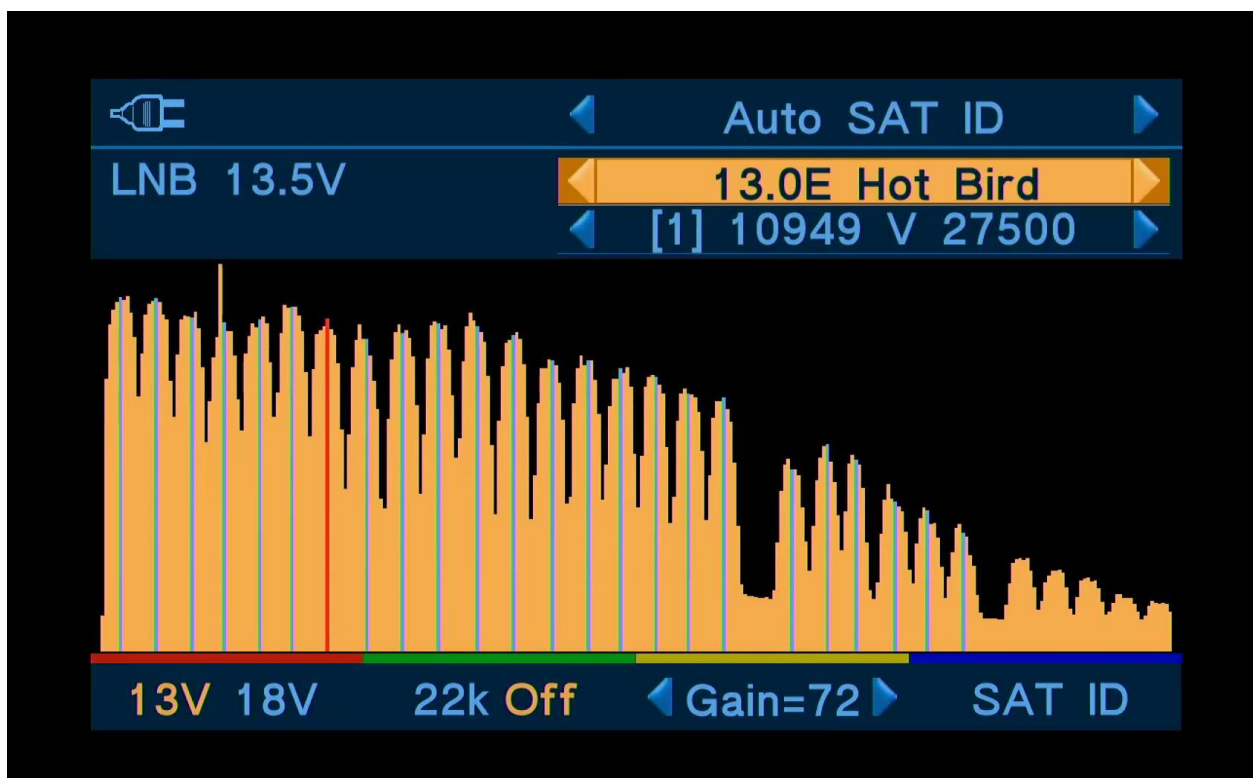

RED key – Polarization switch Horizontal (18V) / Vertical (13V).

GREEN key – Low-High band switch HI / LOW (Tone 22k On / Off).

YELLOW key – Signal gain control (Gain). You may need to adjust gain (with left-right buttons) when LNB is providing too low or to high signal, or when cable is too long, etc.

BLUE key – Satellite Identification function (SAT ID). After you press it, the Meter will analyze the signal, find all the possible transponders, and then analyze the NIT/SDT data for all of the transponders, starting from the strongest one. After that, the services/channels list, network, provider, orbital position information are displayed, so you can be sure that you get the signal you're looking for. **NOTE! Due to DVB-standard, sometimes it may take up to 10 seconds to display full info.**

Arrow keys ▲, ▼, ►, ◀ and OK – Are used for navigation and to select/change items. Here you can select:

Automatic or **Manual** SAT ID mode (in **manual** mode user can move cursor to some chosen transponder to enjoy the SAT-ID function on this particular frequency)

Satellite from list, Transponder from list

Spectrum UHF

This menu is used for terrestrial antenna pointing. The UHF spectrum (450-1050MHz band) displays all digital multiplexes and other signals (including the LTE signals) in real time. Remember to adjust signal gain for better spectrum diagram shape. Select the channel you're looking for (you can see selection by red color). Rotate and move antenna to get best signal/noise ratio. This mode supports active terrestrial antenna and multiswitches (**NOTE:** Combo model only!. If you have Combo model, you can select voltage injected to cable: OFF/5V/13V.)

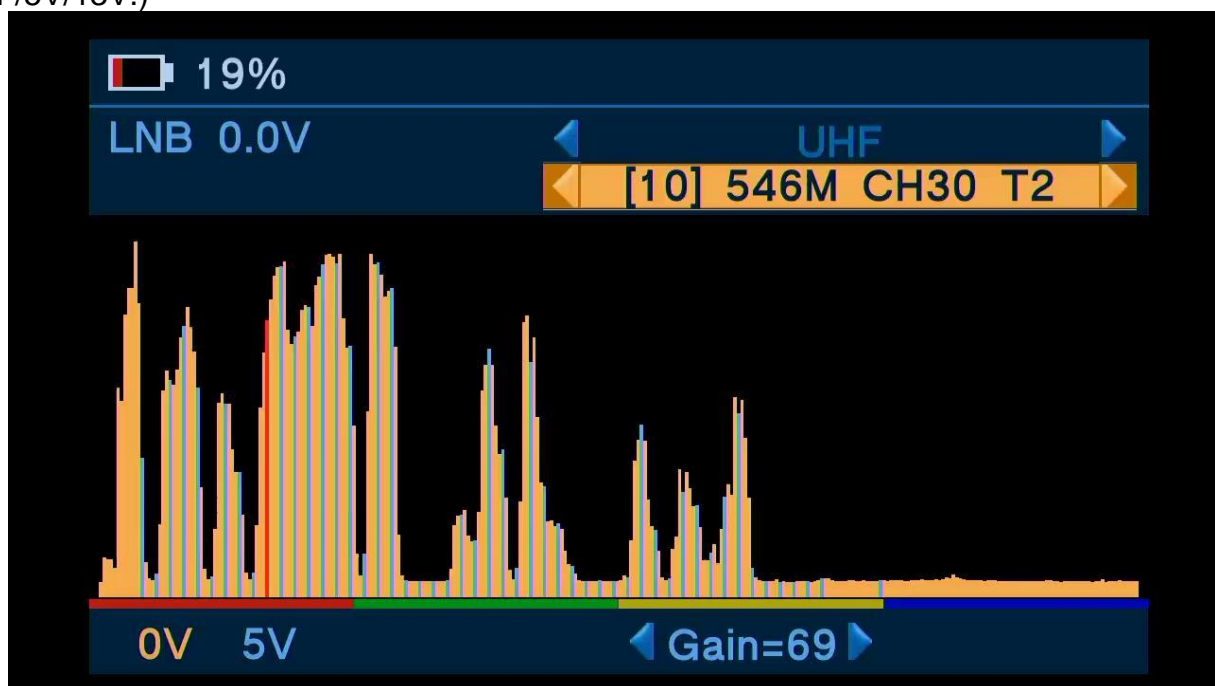

RED key – LNB Power switch ON (5V or 13V) / OFF (0V).

YELLOW key – Signal gain control (Gain).

Arrow keys ▲, ▼, ►, ◀ and OK – Are used for navigation and to select/change items. Here you can select:

- multiplex from list,
- terrestrial band from list of available (for Combo only)

NOTE. Terrestrial database can be created and download, as xml settings from usb stick.

Motor

This mode provides wide possibilities for USALS and DiSEqC1.2 positioners control. Menu items and functions are almost the same as SAT Spectrum mode, including SAT ID and LNB mode control.

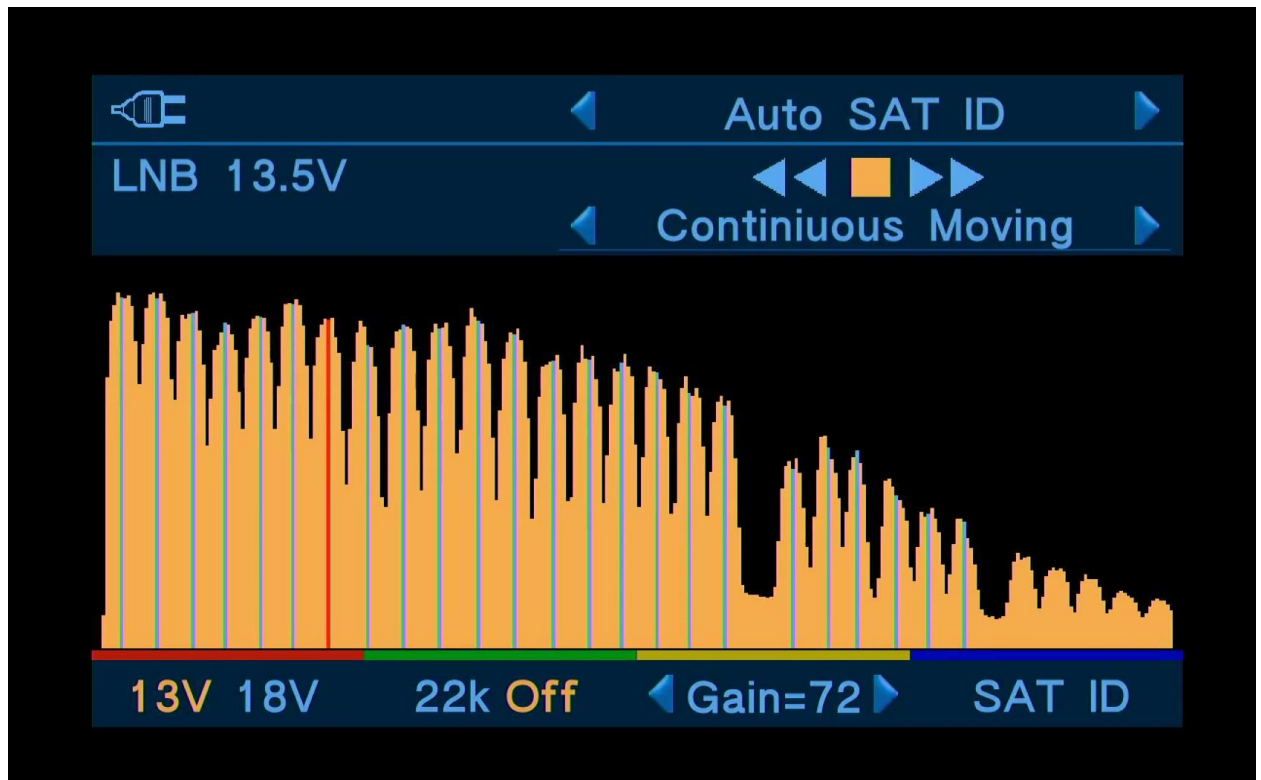

RED key – Polarization switch Horizontal (18V) / Vertical (13V).

GREEN key – Low-High band switch HI / LOW (Tone 22k On / Off).

YELLOW key – Signal gain control (Gain).

BLUE key – Satellite Identification function (SAT ID). Function is same as in the Spectrum mode, read above.

Arrow keys ▲, ▼, ►, ◀ and OK – Are used for navigation and to select/change items.

Here you can select:

Automatic or **Manual** SAT ID mode (in **manual** mode user can move cursor to some chosen transponder to enjoy the SAT-ID function on this particular frequency)
DiSEqC command from list, available action and options for command

SAT Signal (Signal Measuring menu).

This mode has fast and responsive scales for **EFF**ective satellite hunting. But main purpose of this mode is the fine tuning and various parameters optimization, to get the best signal quality: AGC, SNR, BER, MER. The AGC scale is duplicated on the led scale by red color light, when there is signal lock, the color becomes green and duplicates the SNR scale values. It is very informative and helpful.

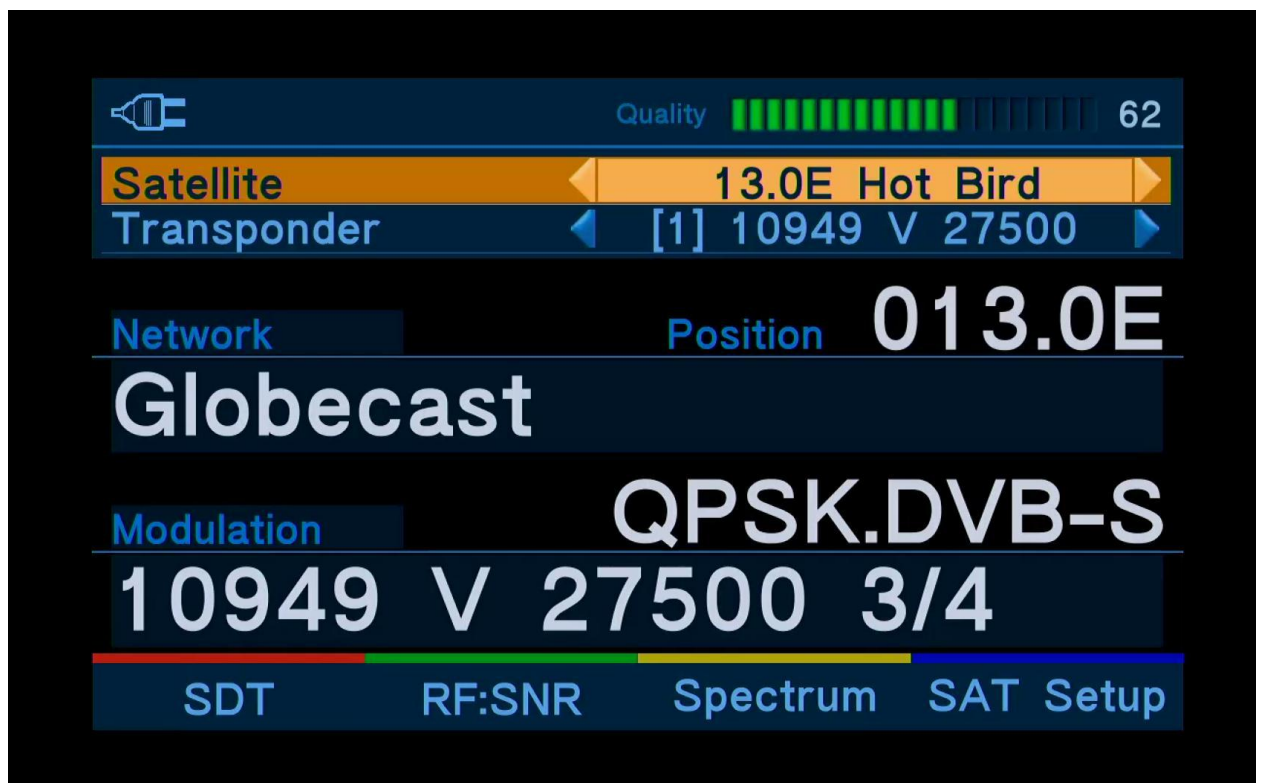

RED key – switches stream analyzer modes: NIT and SDT.

NIT (Network Information Table) – information about network, transponder frequency, symbol rate, polarization, fec, modulation. SDT (Service Description Table) – available services/channel list and it is possible to fast-watch (preview) FTA channels without scanning them.

This mode helps to perfectly align the dish/antenna. Also, this mode can be useful for DXers and installers as stream analyzer for monitoring and identification new frequencies and feeds, not defined in public sources. For example, in service list easy to see, SDTV/HDTV/RADIO services or DATA software update services for providers equipment (set top boxes or CAMs). Use front panel color hot keys for fast access in/to spectrum analyzer mode and signal measuring mode.

NIT:SDT

(Note! Direct call of this function from start menu is available only in 1000S+ model only, not in Combo)



GREEN key – switches between RF:SNR and BER:MER.

SNR (Signal Noise Ratio) – this is indicator of signal (also called “carrier”) to noise ratio. Here user can monitor LNB mode voltage and loading current. Orbital position and provider name can be displayed here after signal lock.

BER (Bit Error Rate) – here you can evaluate quality of digital stream.

MER (Modulation Error Ratio) – here you can see quality of analog signal. Also, within this menu user can see signal constellation. This Constellation is used to see the modulation type and signal quality by picture. When signal is better, the picture looks like focused dots. When signal is worse and critical, the diagram dots are larger, blurred and you can see the noise.

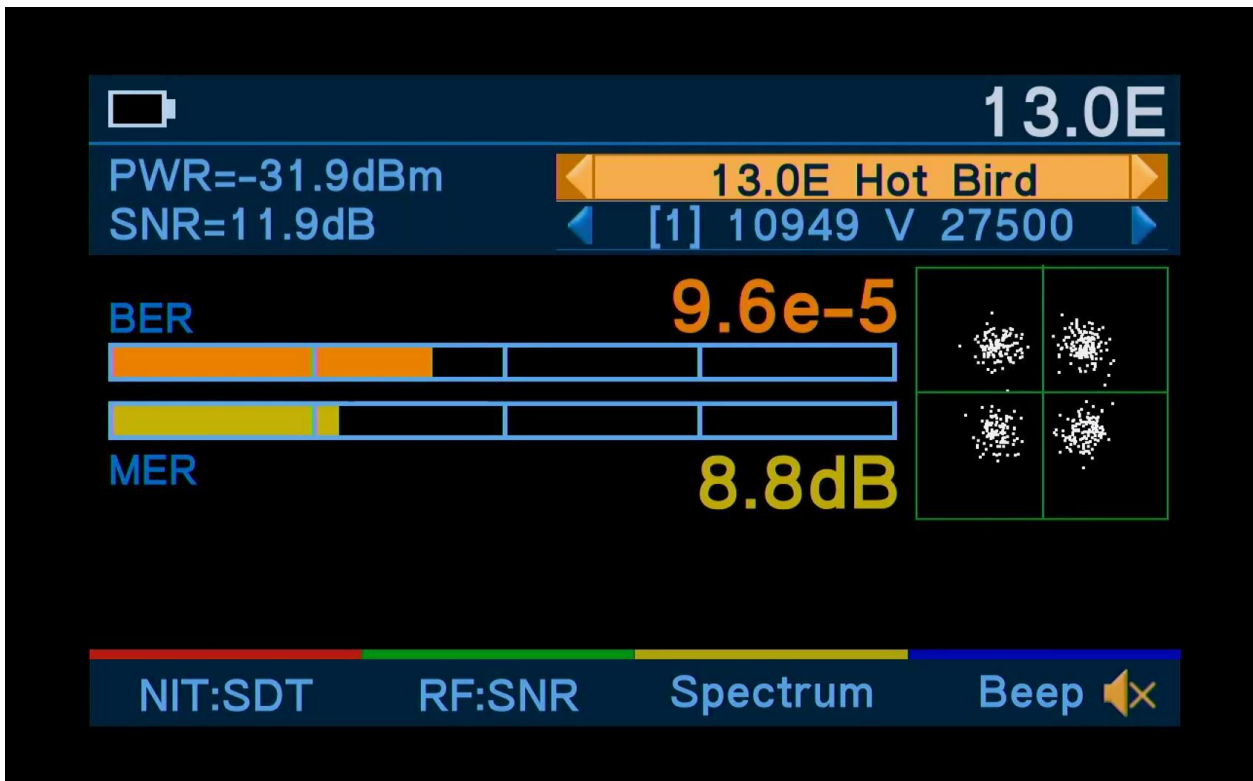
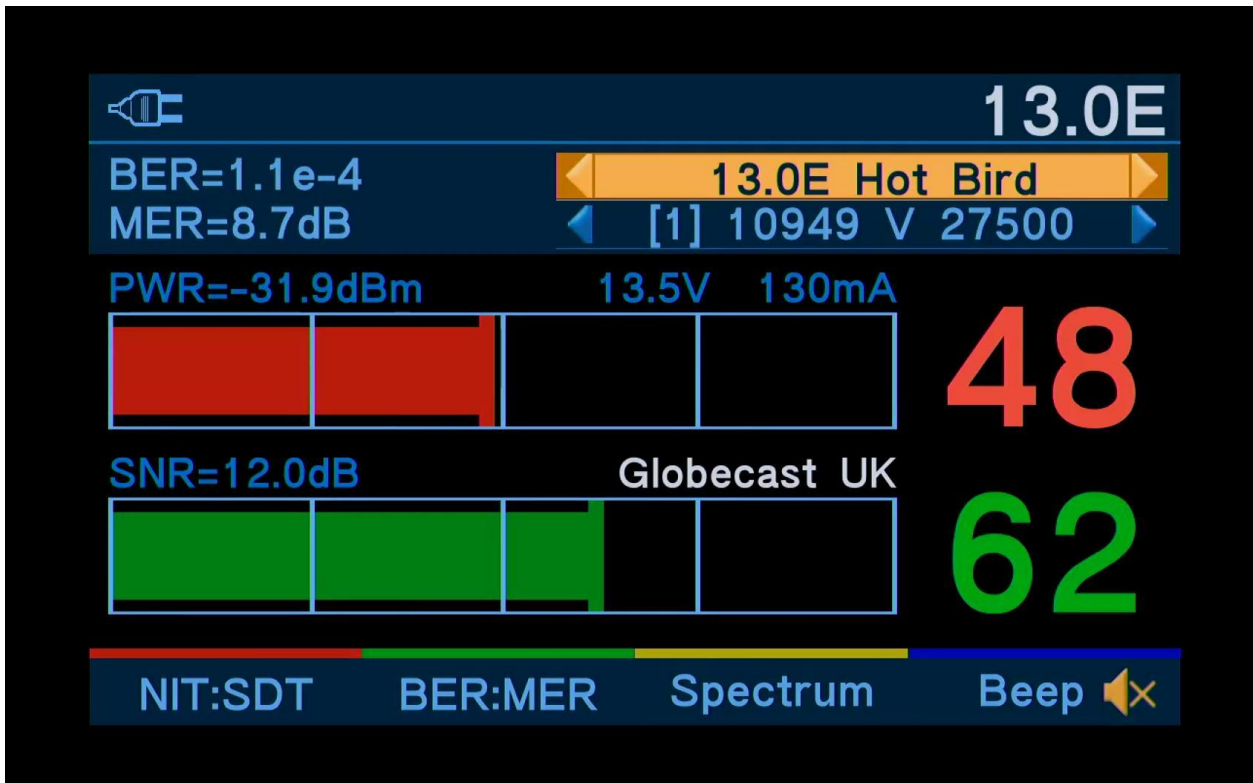

YELLOW key – Spectrum menu direct call.

BLUE key – Beep ON/OFF. Sometimes, it is more **EFF**ective to use the Audio Beep Function for installation. You can enable built-in speaker to control the signal levels. The melody/tonality of the audio signal, depends on signal level. Rule: melody frequency is higher -> signal level is higher. (Enable or disable this beep mode by front panel blue key).

TV Signal (available in 1000Combo model only)

Menu helps to fine-tune the terrestrial signal for specific multiplex. User can change input band VHF/II, VHF/III and UHF and select there the channel/multiplex. The terrestrial database can be created and downloaded from usb stick as xml file.

RED key – switch stream analyzer mode NIT and SDT.

NIT (Network Information Table) – information about network, multiplex frequency, signal rate, modulation, etc. SDT (Service Description Table) – available services/channel list and it is possible to fast-watch (preview) FTA channels without scanning them.

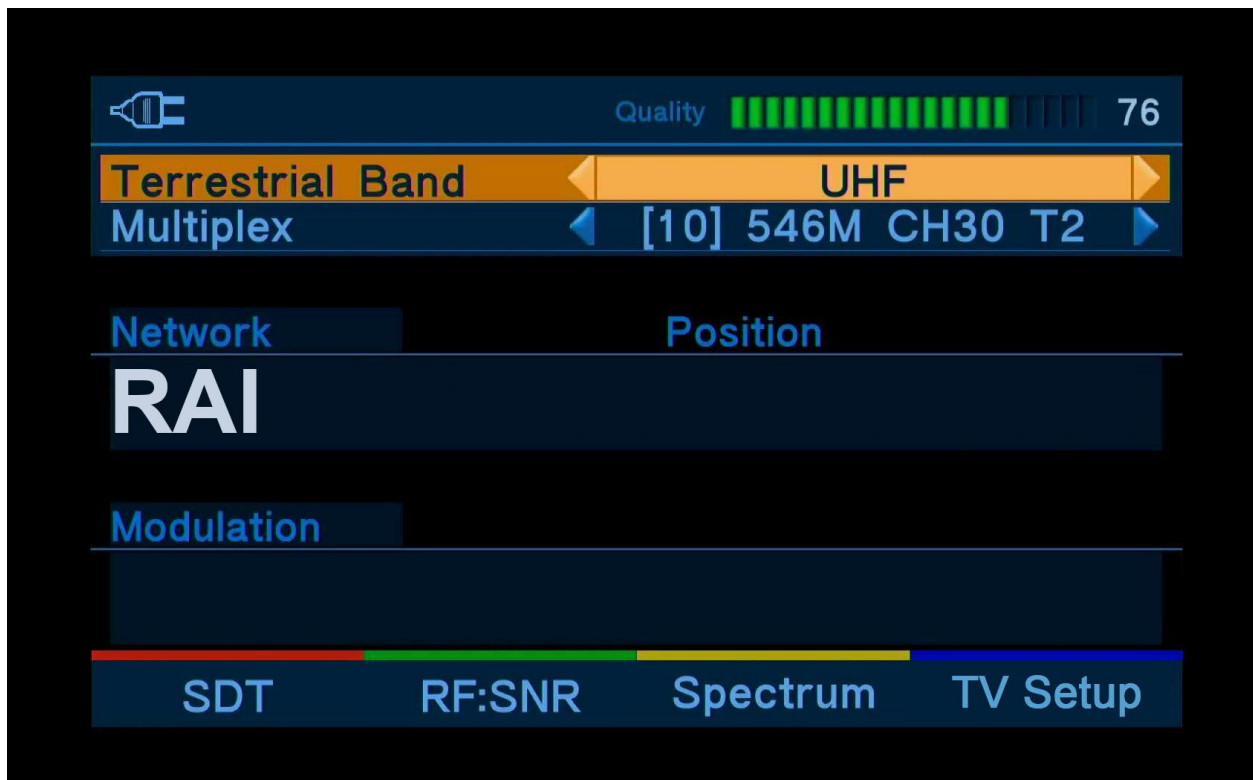

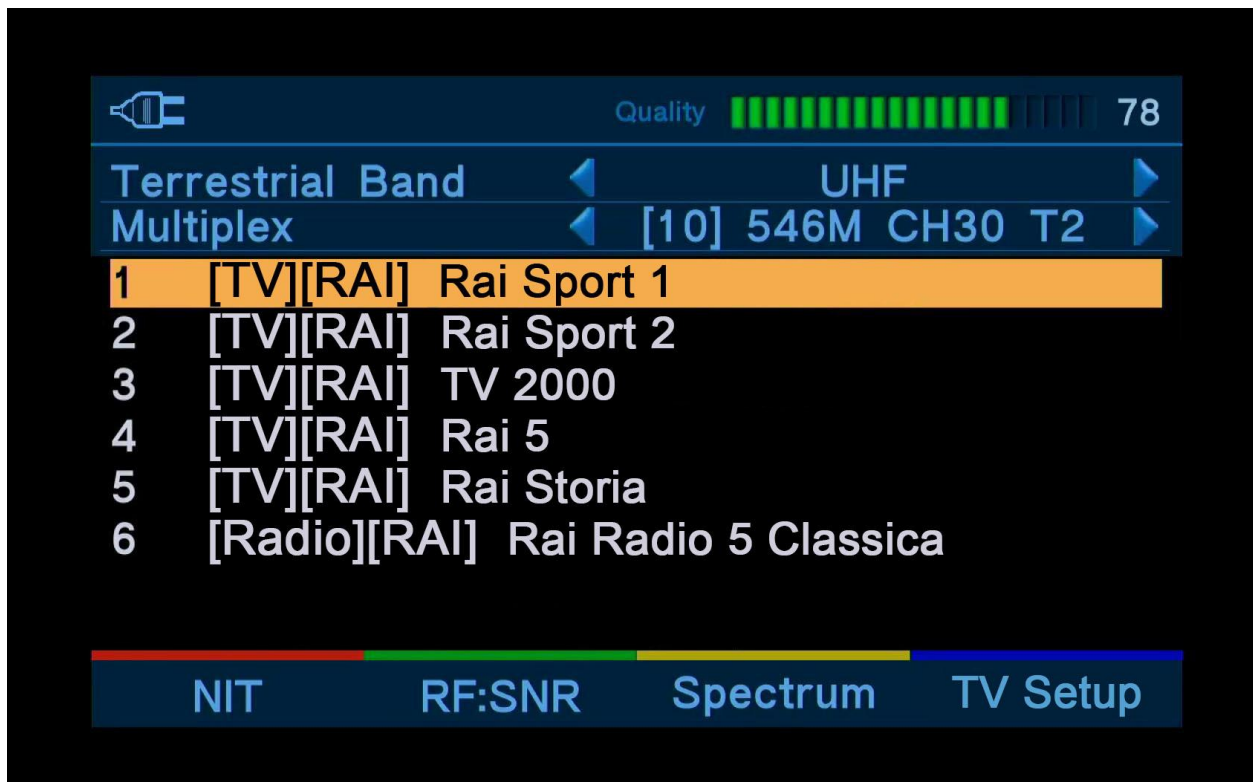

GREEN key – switches between:SNR and BER:MER.

SNR (Signal Noise Rate) – it is indicator of signal (carrier) to noise ratio. Here user can monitor antenna voltage and loading current. Provider name can be displayed here after signal lock.

BER (Bit Error Rate) – here you can evaluate quality of digital stream.

MER (Modulation Error Ratio) – here you can see quality of analog signal. Also, within this menu user can see signal constellation. This Constellation is used to see the modulation type and signal quality by picture. When signal is better, the picture looks like focused dots. When signal is worse and critical, the diagram dots are larger, blurred and you can see the noise.

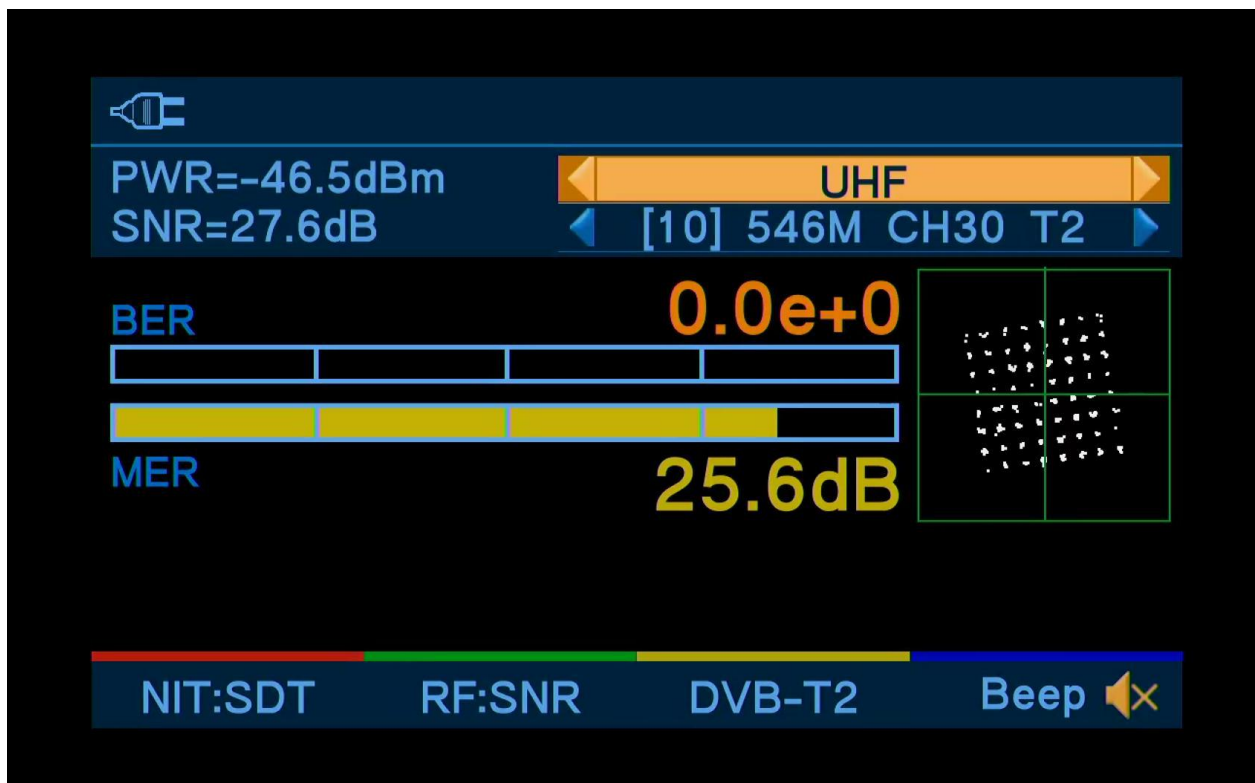
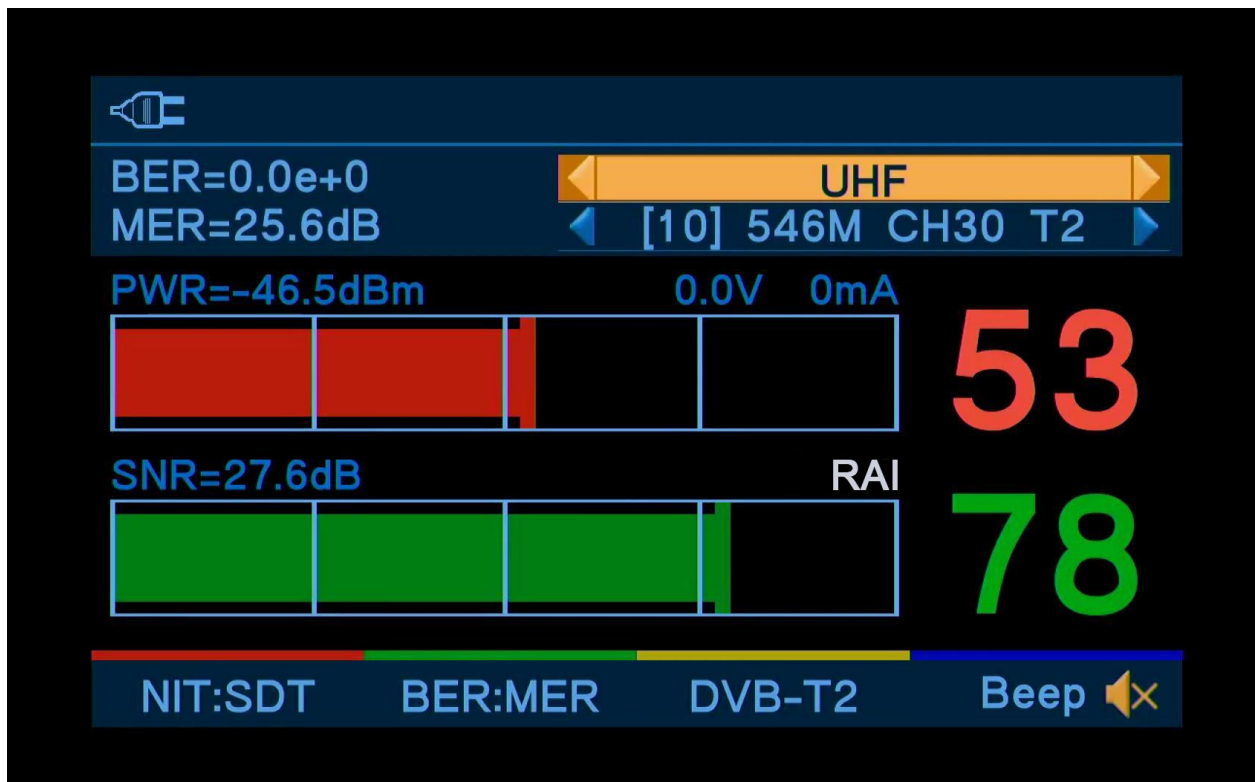

YELLOW key – Spectrum menu direct call or DVB T /T2 mode express change

BLUE key – Beep ON/OFF. Sometimes, it is more **EFF**ective to use the Audio Beep Function for installation. You can enable built-in speaker to control the signal levels. The melody/tonality of the audio signal, depends on signal level. Rule: melody frequency is higher -> signal level is higher. (Enable or disable this beep mode by front panel blue key).

Watching TV

Here, you can get to the scanned channels watching. (If channels aren't scanned yet, you will be offered to do so). User interface is very similar to generic set top box menu.

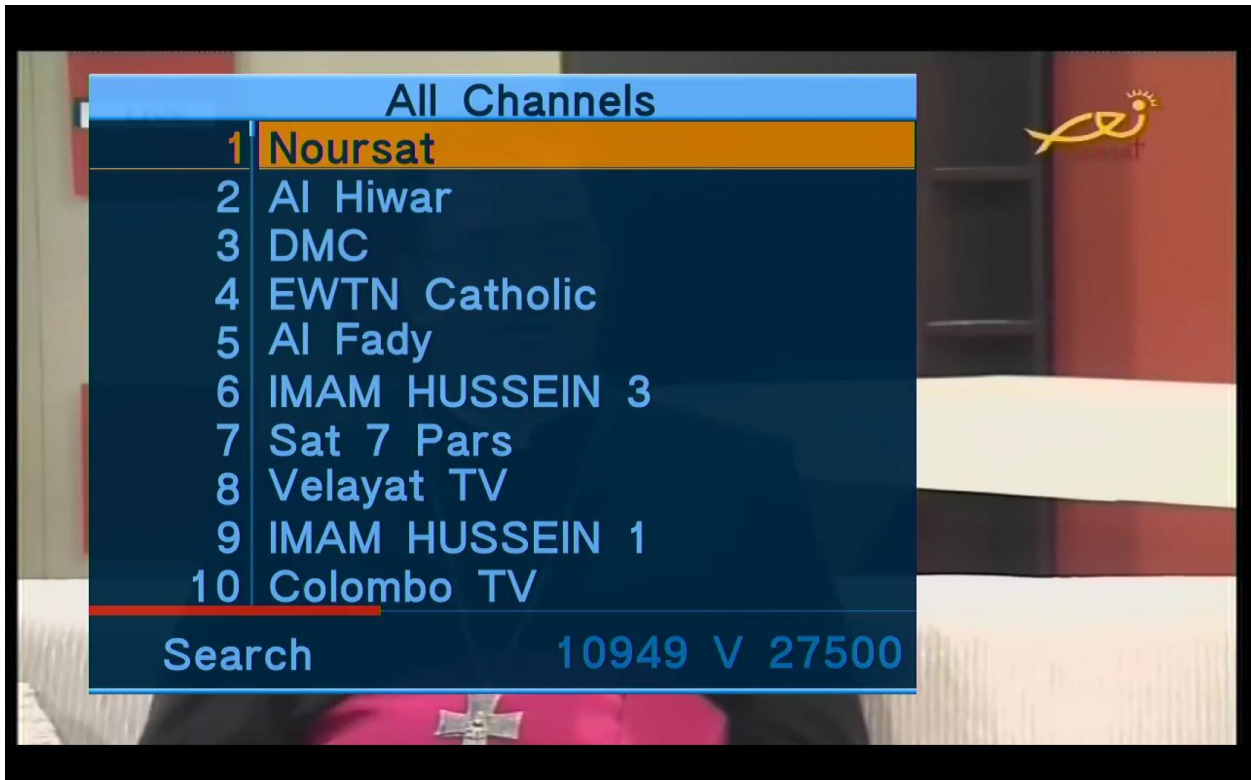

OK button– All channel list call (press Menu button, then left/right arrows to call favorite lists)

GREEN key – audio track change.

YELLOW key – EPG information

RED key – channel scanning mode.

SAT Setup

This is menu very similar to set top box installation menu. Here user can edit database, select LNB mode, DiSEqC mode etc and then to scan channels.

Arrow keys ▲, ▼, ►, ◀ and OK – Are used for navigation and to select/change items.

RED key – Channel scan manager. Blind scan, Network scan, Single TP scan, Autoscans, FTA/ALL scan options are supported

GREEN key – Embedded satellites and transponders database editor.

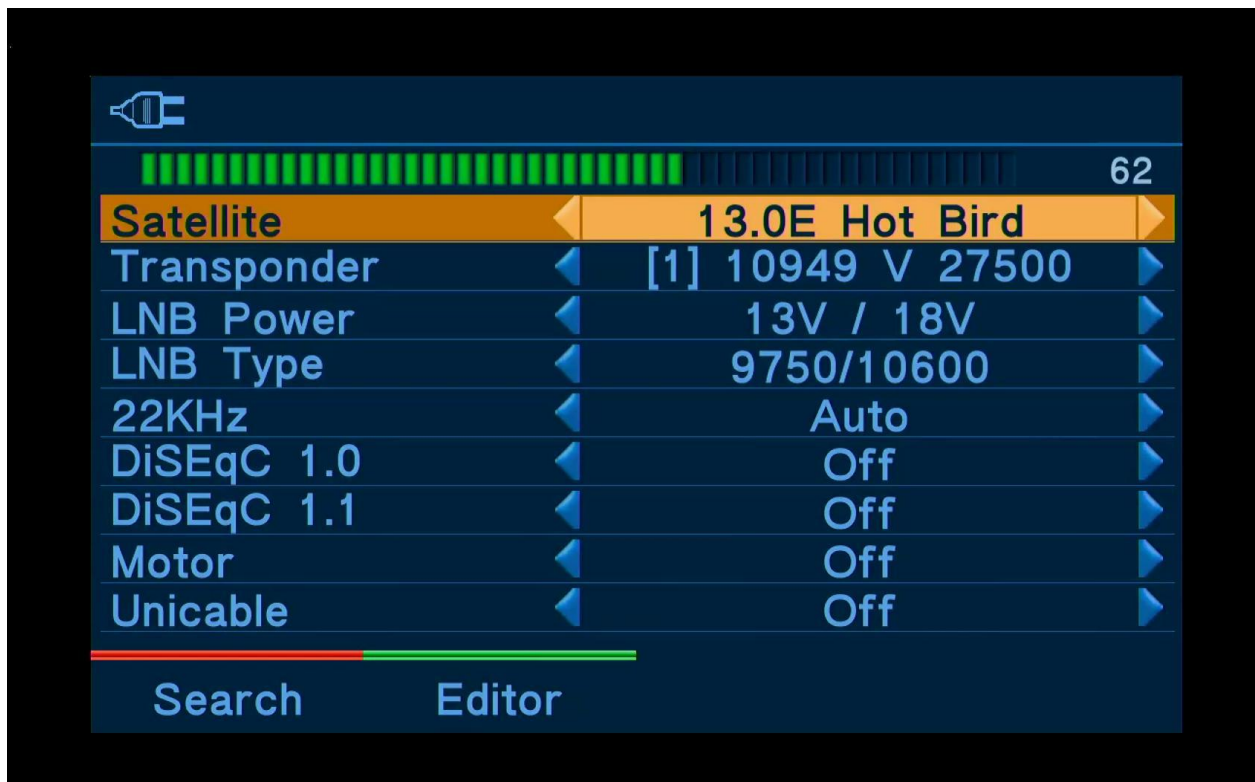

TV Setup (available for 1000Combo model only)

This menu is very similar to terrestrial set top box installation menu. Here user can edit some options - LNB power mode 0/5V/13V, standard of broadcasting DVB-T/T2 and then to scan channels.

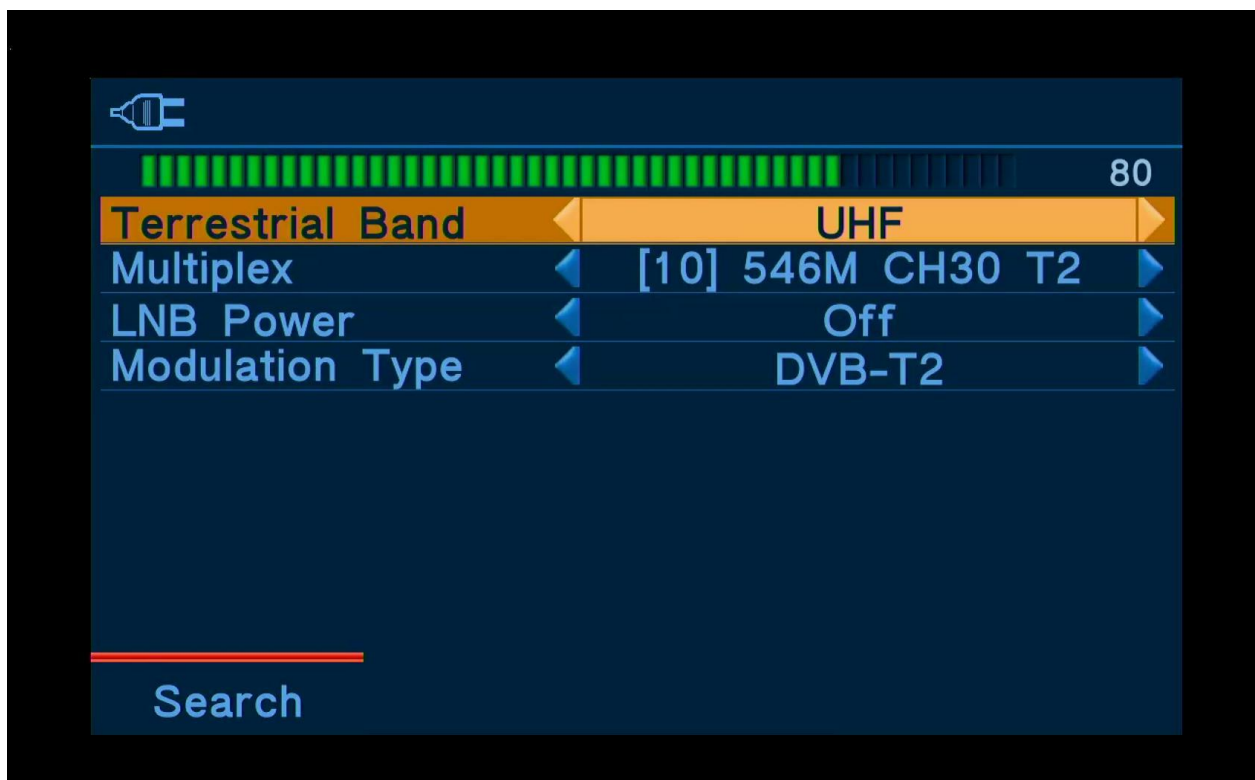

Arrow keys ▲, ▼, ►, ◀ and OK – Are used for navigation and to select/change items.

RED key – Channel scan manager. T/T2 Auto-scanning, Single multiplex scanning, FTA/ALL scanning options are supported

System Settings

Basic options setup. Here user can change language of interface and audio, GMT offset, firmware and settings update and etc.

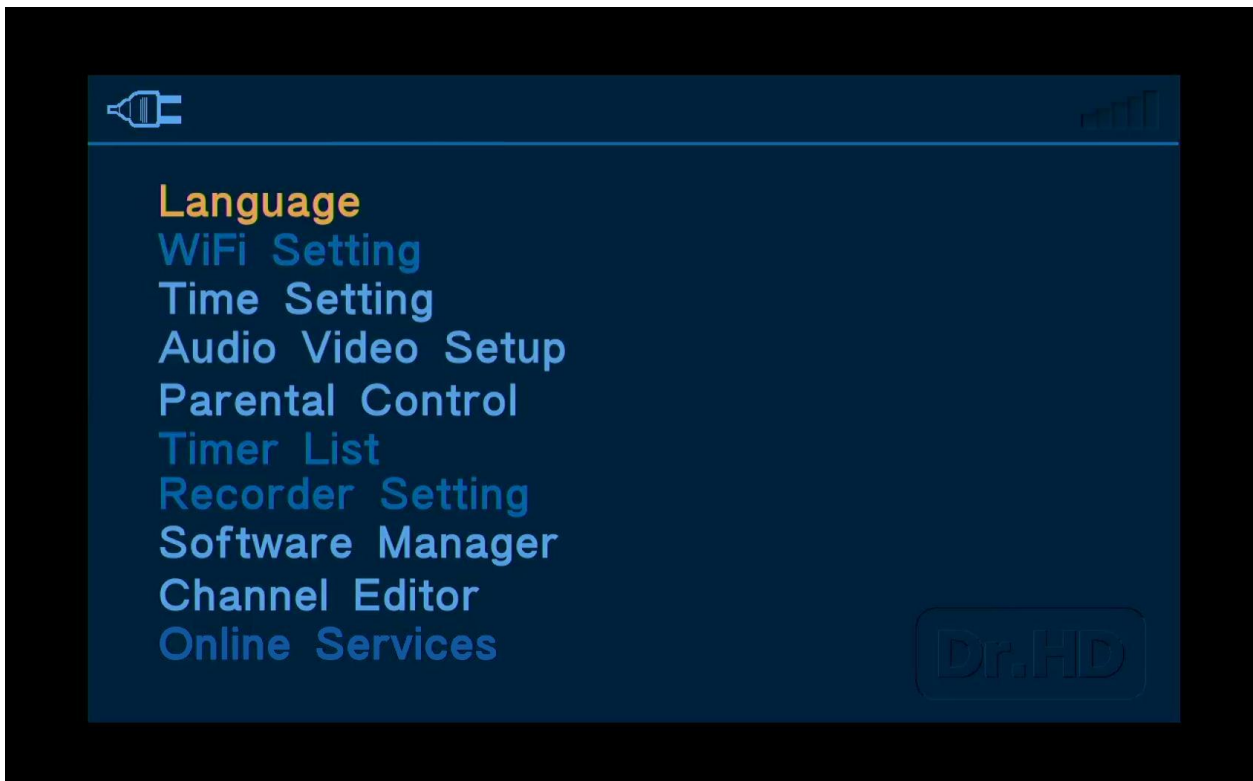

Arrow keys ▲, ▼, ►, ◀ and OK – Are used for navigation and to select/change items.

VIII. CCTV mode

NOTE! The CCTV mode will be enabled automatically, when you insert the special CCTV-cable into the AV IN connector. After this, CCTV camera will get 6...11V power supply from the main battery (voltage depends on mode of work, and normally it is enough to test-power the CCTV cameras), and the display will show the video picture from Camera, and audio will play on the built-in speaker. The CCTV power output has shortcut protection. This mode supports the analogue CCTV with CVBS PAL/NTSC color system and mono audio.

IMPORTANT! The CCTV mode is a power-saving mode! Therefore, to return back from CCTV mode, you must reboot the Meter! Unplug PSU from Meter (if was connected) turn the main switch to "OFF" then "ON".

IX. Remote control unit (RCU)

Using RCU is one more way to control the Meter, especially in the Set-Top Box mode. We did our best to make RC as easy as possible and user-friendly for all potential customers.

The RCU buttons

POWER (RED button in the left-upper corner of RCU) toggles Receiver between standby and operation modes.

TV/RADIO (to the right of POWER-button) switches Receiver between TV and Radio modes.

MUTE (in the right-upper corner of RCU) switches off the sound temporarily. Press again to switch it back on.

0, 1, 2, ...9 - Numeric buttons for entering numbers

NOTE: FORMATTING VIDEO! Pushing '0' (zero) button on your Remote, while you are watching video, zooms in the picture to the TV-screen, keeping the proportions of the picture.

EPG key is used to show the Full TV/Radio program Guide for current program (if the Broadcaster provides the EPG information for the channel you are watching).

INFO is used to show information ("prompts") referring to the Current program (if provided by the Broadcaster) and to monitor the current channel parameters.

MENU is used to enter or exit the main menu.

BACK is used to return to a previous menu. **Hint:** To get out of any menu, push BACK key several times.

ARROW BUTTONS (Left- Right, Up-Down) are used to navigate menus, to move cursor for changing options for a menu item. While watching a program you can use these buttons to increase the audio volume (right arrow) and decrease the audio volume (left arrow). Up and Down buttons will allow you to zap the TV channels in fast and easy way and to go on watching TV programs

OK -button displays the channel list. It is also used to select/confirm menu items..

REC (Red button). In some versions of software, activates the recording of video. (By means of "PVR"= Personal Video Recorder). USB stick must be used as storage.

AUDIO is used to choose audio-mode (Stereo, Left, Right), as well as to choose language audio-track (Some channels have several audio-tracks).

STOP (Yellow button). Finishes the Recording or Playback.

Color (RED, BLUE, GREEN and YELLOW) buttons are special hot-keys, having different functions in different menus. The hint on current function is displayed on the screen.

Buttons “◀, ▶, ▶II” below the color buttons (when available) are used in special firmware versions with media player features to change start/pause playback and speed as well as for “Fast Forward” and “Rewind” functions.

X. Firmware USB update

We are continuously improving the Dr.HD™ 1000S+ / 1000Combo software, adding new functions, in order to provide the best functional and convenient product for our customers.

User can find information about firmware of Meter. To do this, go to Menu ->System Settings -> Software Manager .

How to update firmware:

1. Download the latest version of firmware at official Website: WWW.DR-HD.COM .
2. Unzip files to the **root** folder of the USB stick. Firmware files have “ssu” extension.
3. Connect the USB stick to Meter.
4. **Be sure that Meter’s battery has 20% charge or more** , otherwise connect PSU, to prevent update failures with power off reason.
5. Select Menu ->System Settings -> Software Manager- >Upgrade, press OK.
6. Select ssu or xml file for updating, and press Ok to start update.

You will see pop up warning messages and running progress bar. The update requires not too much time, within 2-3 minutes. Do not do anything during that time. After successful update finder will reboot by itself and will enter the main menu.

NOTE: NEVER touch the main switch or disconnect PSU when doing software update or downloading the XML files.

Follow us for new SW updates for more functions and other upgrades! You can check our official site, but better idea is to follow us on FaceBook, also there are YouTube videos that may help you.

XI. Database editor and settings USB update

The Meter has simple embedded satellite+transponder database editor. It helps to insert some changes in settings in any moment of installation. For example, you can change polarization of transponder, you can add new transponders, etc.

For bigger changes it is wiser to use your PC. In this case, you can record the **satellites.xml** and **terrestrial.xml** database files to the USB stick and downloaded to Meter from USB.

How to update settings:

1. Download database files at the official site: WWW.DR-HD.COM .
2. Unzip files to the USB stick's root folder. The setting database files always have "xml" extension.
3. Connect the USB stick to the Meter.
4. **Be sure that Meter's battery has 20% charge or more** , otherwise connect PSU, to prevent update failures with power off reason.
5. **NOTE!** The sequence of downloading is critical. Satellites.xml must be downloaded before terrestrial.xml and they should be download together (one right after another) always. Call Menu ->System Settings -> Software Manager- >Upgrade, press OK.
6. In simple file manager select xml file and press Ok to start update.

You will see pop up warning messages and running progress bar.

Attention! Embedded database has memory limitations:

- Maximal satellite items count is 61.
- Maximal transponder items count is 2000.
- Maximal terrestrial band count is 3 for 1000Combo (VHF I/II, VHF III и UHF) and 1 for 1000S+ (UHF only).
- Maximal satellite name length is 15 Latin symbols

XII. Editing the Database on PC.

Some customers may like editing the Database on PC. In this case, you can edit the XML file with some editor able to work with XML files.

Then, the edited file can be recorded to USB drive and downloaded to Meter. But **REMEMBER TO RESPECT the maximal satellite and transponder counts, as above.**

Specifications

Tuner input	Connector for the cable from LNB	IEC169-24, female
	Input IF frequency range	450MHz ~ 2150MHz (1000S+) (maximal BW in Spectrum mode) 45MHz ~ 2150MHz (1000Combo)
	Input IF signal level range	-70dBm ~ 20dBm (satellite mode) -100dBm ~ 20dBm (terrestrial mode)

	LNB (antenna) supply	DC 13/18V 500mA* 4.3/13V 200mA (1000Combo)
	LNB switch control	22KHz
	DiSEqC	Ver 1.0/1.1/1.2/USALS/Unicable Compatible Upgradeable to DiSEqC 2.0
Demodulator	Demodulator	DVB-S QPSK, DVB-S2 QPSK/8PSK/APSK16/APSK32 (all models) DVB-T QPSK 16QAM/64QAM, DVB-T2 QPSK 16QAM/64QAM/256QAM (only on Combo)
	Symbol rate	1 ~ 45MS/s
	Spectral inversion	Auto conversion
Video decoder	MPEG 2,4	MPEG-2, MPEG-4, H.264 AVC and Less
	Data Rate	up to 15M bits/s
	Video format (CVBS)	PAL, NTSC
	Video format (HDMI)	FULL HD 4:3/16:9 1920x1080p/i, 1280x720p, 720x576p/i, 640x480p/i
Power supply	Power consumption (max)	24W active, 0W sleeping
	Supply voltage	100V ~ 250V
	Supply frequency	50Hz ~ 60Hz
	Battery	Built-in Li-ion, replaceable (8.4V)
	Battery working time	~ 2 ...7 hours, depends on mode and (LNB) load, typical 3+ hours
Rear Panel connectors	BATTERY ON/OFF	Battery switch
	USB 2.0	150mA, A-Type
	HDMI	Digital HD-Video/Audio output
	Audio(MONO)/Video (CVBS) output	With using cable-adapter 3 RCA
	RS232	With using cable-adapter DB9

	Audio (Mono)/Video (CVBS) input, DC12V output	With using cable-adapter 2 RCA and DCIN
	Digital tuner input	IEC169-24
	Power DC	From DC adapter 12V 2A (other options, read more above)
Keypad	Dip membrane buttons	
Display	LCD Display	LCD 3.5' 320x240
Size & Weight	Size (W x H x D) (without connectors)	105x30x130, mm
	Weight (Netto)	~0,5 kg

Attention! We are continuously improving the Dr.HD™ 1000S+ / 1000Combo software and hardware, adding new functions, in order to make it the MOST EFFECTIVE, functional and convenient product for our customers. Therefore, we reserve the right to make changes for the benefit of our customers. That is why some functions described in this manual might be somewhat different from what you see in your Dr.HD™ 1000S+ / 1000Combo. That means that we have improved software/hardware for your convenience!

We hope you enjoy using our Dr.HD™ 1000S+ / 1000Combo!

– From creators of Dr.HD™ 1000S.

© 2016 Dr.HD
WWW.DR-HD.COM
info@dr-hd.com